

Interclamp®

The right connection



DLHonline

0161 223 1990



01. Welcome

Interclamp is a global brand of versatile high quality malleable iron pipe fittings with a multitude of uses. Designed for easy, simple and fast erection of rigid structures by hand with the minimum of tools, Interclamp is a cost effective, efficient system, particularly compared with traditional methods of construction such as welding, where specialist tools, extensive training and experience are required.

Due to the simple to specify wide range of Interclamp fittings held in stock, the components for permanent or indeed temporary tubular structures can be easily ordered and quickly despatched to your premises or site. The lack of prior fabrication required provides clear benefits over alternative types of construction methods, due to quick lead-times and savings in transport costs as a result of the off-the-shelf “kit form” of the Interclamp system including tubes.

The premium features of our product have firmly placed Interclamp as a leading brand of choice for tubular clamp components worldwide for many years.

More than just handrails...



Simple to specify ● Easy to order ● Rapid to assemble

02. Information

Design & Materials

Interclamps are made from malleable iron manufactured in conformance with BS EN 1562:2012, a dependable and well proven material for this type of product. The fittings are hot-dipped galvanised to BS EN ISO 1461:2009, giving a durable corrosion resistant finished surface for extended life. A secondary additional coating is then applied over the top of the galvanising, to enhance further the corrosion protection and to offer a premium quality, aesthetically pleasing appearance. High quality stainless steel setscrews, which are specified in the optimal size

Sizes

Five different size ranges of Interclamp are available as shown in the table, hence a suitable size can be selected for any particular application. Interclamps are easily identified by a type number of each design, e.g. 125, followed by a size code, e.g. D48, the latter part of which corresponds with the approximate outside diameter of the tube to be used (48.3mm = 1 1/2" nominal bore in this case). Hence a 90° elbow suitable for an 1 1/2" nominal bore tube in this example would be denoted as a 125-D48.

Interclamp Size	Nominal Bore	Outside Diameter
A27	3/4"	26.9mm
B34	1"	33.7mm
C42	1 1/4"	42.4mm
D48	1 1/2"	48.3mm
E60	2"	60.3mm

TÜV Rheinland Product Safety Type Approval and other Formal Independent Assessments



The core range of Interclamps is subject to periodic rigorous testing and continuous product safety type approval by TÜV Rheinland, the leading independent test house across the globe. Furthermore, a series of stringent vibration endurance tests has been successfully passed, which was conducted by a UKAS-accredited independent test laboratory, in order to evaluate the vibration resistance of the standard Interclamp setscrews. Beam tests for uniformly-distributed loads have also been carried out by an independent testing facility.

Powder Coating

For customising to specific end-user requirements, powder coating may be applied over the galvanising of the tubes in a wide spectrum of RAL or BS colours on request, including Interclamp Safety Yellow. Where necessary, powder coating may also be applied to the Interclamp fittings as well. Please contact us with your requirements, so that we can discuss the options available to meet the needs of your exact specification.



03. Features

Trust Genuine Interclamp®

To differentiate the Interclamp range from other systems and methods of construction, various advanced features have been incorporated into the design, production and finish of the fittings, with the clear aim of optimising the

High Quality Galvanised Finish

Interclamp components are hot-dipped galvanised to BS EN ISO 1461:2009 giving a corrosion resistant finish for an extended life.

Interclamp Double Coating

Interclamp fittings feature a secondary coating over the hot-dipped galvanising to enhance corrosion protection and to extend the life of the product. This gives Interclamp the benefit of a premium quality, aesthetically pleasing finish.

Easy Identification

Each fitting is clearly marked with the type & size for ease of identification.

Stainless Steel Screws

For increased corrosion resistance.

Recognised Brand

Every fitting carries the recognised Interclamp brand as a sign of quality and to aid traceability.

Product Consistency

Optimal production techniques and stringent quality controls ensure a reliable and consistent product.

Vibration Resistance

Interclamp fittings have been successfully subjected to stringent vibration endurance resistance tests by an accredited independent test laboratory.

Product Testing

The core range of Interclamp fittings has been tested and type approved by TÜV Rheinland, the leading worldwide independent test house. Additional vibration resistance assessments and load tests have also been conducted by other independent test facilities.



04. Applications

Although most commonly used in handrailing and safety guardrailing situations, the variety of structures made possible by the wide extent of the versatile range is only limited by your ingenuity. In addition, custom designed Interclamps are available on request. Illustrated in this brochure are the main types of Interclamp designs available. Please note that we are continuously expanding and developing our range, so if the fitting or size you require is not shown, please contact us. Certain illustrations show powder coated Interclamp fittings, tube and pedestrian barriers available at extra cost.

Handrails

Fences & Security Fencing

Playground Equipment

Milking Parlours

Railway Guardrailing

Garment Racking

Market Stalls

Cycle Racks & Trolley Bays

Sports Practice Nets (Golf, Cricket, etc.)

Sports Grounds & Arenas

Machinery Guards & Enclosures

Highway Control Installations

Road Signs

Roof Top Fall Prevention Systems

Heavy Duty Workstations

Safety Guardrails

Retail Displays & Shopfitting

Racking

Agricultural Enclosures

Greenhouses

Exhibition Stands & Displays

Industrial & Domestic Furniture

Temporary Buildings

Wheelchair Access Ramps

Theme Park Queue Management

Canopies & Car Ports

Solar Panel Supports

Roof Guardrails

Film Sets

Cable Reels

General Signage

Civic Amenity / Recycling Sites

Shipbuilding

Access Platforms / Mezzanine Floors

Water Treatment Works

Staircase Handrails

Commercial Billboard Frames

Smoking Shelters







































Please Note: Some photographs are of foreign applications which do not necessarily conform to all market specifications. Your attention is drawn to the disclaimer on the back page of this brochure.

05.Clamp Range

101 A27 B34 C42 D48 E60		101 C42/B34 D48/B34 D48/C42 E60/D48 B34/C42 C42/D48		104 A27 B34 C42 D48 E60		116 A27 B34 C42 D48 E60		117X D48 Retro-Fit	
117X D48 Retro-Fit		117Y D48 Retro-Fit		117Y D48 Retro-Fit		117Y D48 Retro-Fit		119 A27 B34 C42 D48 E60	
119 C42/D48		123 40° - 70° B34 C42 D48		124 15° - 60° B34 C42 D48		125 A27 B34 C42 D48 E60		125 D48/C42	
127 30° - 45° B34 C42 D48		128 A27 B34 C42 D48 E60		129 30° - 60° A27 B34 C42 D48		130 30° - 45° B34 C42 D48		131 A27 B34 C42 D48 E60	
132 A27 B34 C42 D48 E60		133 Plastic A27 B34 C42 D48 E60		134 B34 C42 D48		135 A27 B34 C42 D48 E60		135Y D48	
136 C42 D48		137 D48		138 A27 B34 C42 D48		140 A27 B34 C42 D48		143 A27 B34 C42 D48	
144 B34 C42 D48		145 B34 C42 D48		146 B34 C42 D48		147 B34 C42 D48		148* A27 B34 C42 D48 E60	
149 A27 B34 C42 D48 E60		150 B34 C42 D48		152 0° - 11° B34 C42 D48		153 0° - 11° B34 C42 D48		154 0° - 11° B34 C42 D48	
155 0° - 11° B34 C42 D48		156 0° - 11° B34 C42 D48		158 A27 B34 C42 D48 E60		160 A27 B34 C42 D48 E60		161 A27 B34 C42 D48 E60	

* Illustration shows multiple fittings

161 B34/A27 C42/B34 D48/B34 D48/C42 E60/D48		165 B34 C42 D48 E60		166 0-120° B34 C42 D48 E60		167 A27 B34 C42 D48 E60		167M A27 B34 C42 D48 E60	
168 A27 B34 C42 D48 E60		168M A27 B34 C42 D48 E60		169 A27 B34 C42 D48 E60		169M		170 A27 B34 C42 D48 E60	
171 A27 B34 C42 D48 E60		172M* C42 D48		173 A27 B34 C42 D48 E60		173F A27 B34 C42 D48 E60		173M A27 B34 C42 D48 E60	
174 D48		174M D48		175 D48		175M D48		176 A27 B34 C42 D48 E60	
179 A27 B34 C42 D48 E60		182 A27 B34 C42 D48		185 27½° D48		191 27½° D48		192 B34 C42 D48	
197 D48		198 B34 C42 D48		199 B34 C42 D48		232 D48		242 C42 D48	
245 D48		246 B34 C42 D48		251 30° - 45° B34 C42 D48		252 11° - 29° D48		253 11° - 29° D48	
255 11° - 29° D48		256 11° - 29° D48		300* AB CDE	 <p>Hex</p>	302		303* AB CDE	 <p>Security</p>
310		333 Aluminium A27 B34 C42 D48 E60		390 400ml		392 D48 900mm D48 1800mm		394	

06.DDA Assist Range



Interclamp DDA Assist Range With DDA Compliant Handrails

- Smooth, in-line handrail range.
- Compatible for use in conjunction with the standard Interclamp range.
- Helps to meet compliance with the Equality Act 2010 (formerly DDA) and Building Regulations Part M 2013.
- Saddle-type assembly or internally expanding to suit 3.25mm wall tube.
- Optional O-rings for ease of installation and aesthetically pleasing finish.
- Easy accommodation of slopes and access ramps.
- Powder coating available to suit contrasting colour



The Interclamp Assist range has been specially designed to help compliance with the public access requirements of the Equality Act 2010 (formerly DDA) and Building Regulations Part M 2013. In order to give our customers more choice, a range of both internally expanding clamps and saddle type fittings is available, neither of which requires the use of welding, threading or specialist tools. Our classic range of internally expanding fittings requires no riveting or drilling of tube, whereas the saddle-type fittings require less tube cutting and hence easier handrail alignment. No other special fittings are required, which enables full integration with both new Interclamp systems and the refurbishment or upgrading of existing tubular structures to help meet the newer access specifications.

In order to meet the requirements of the above standards, the range forms flush joints with size C42 tube. Tube (and fittings where necessary) may be coated in RAL or BS colours to help meet "not cold to the touch" and contrasting colour requirements. Steps and disabled access slopes may easily be accommodated, facilitating compliance with public access standards.

For C42 size internally expanding Assist fittings (as with type 150), tubes must be 42.4mm od x 3.2mm wall thickness e.g. 1 1/4" medium weight to BS EN 10255 (formerly BS1387). All cut tube ends must be deburred and treated with Interclamp Silver Galvanising Spray or other suitable protection. Optional O-rings may be fitted to each end of the expanding Assist fittings to achieve the best finish.





Interclamp DDA Assist Range

720 C42		721 C42		724 C42		725 C42	
728 C42		729 C42		731 C42		745 C42 D48	
747 C42 D48		748 C42		750 ◇ C42 C42/D48 D48		751 ◇ C42 C42/D48	
797 C42		798* PH2		<p>* Illustration shows multiple fittings. ** Requires 2 x 150-C42 (not shown) or other expanding fittings. ◇ Requires assembly.</p>			
		799* PH2					

A sample of typical configurations

729-C42 + 125-C42		747-C42 + 101-C42 + 133-C42		747-C42 + 125-C42		747-C42 + 104-C42	
724-C42 + 748-C42 + 125-C42		721-C42 + 125 D48/C42 + 101 D48/C42 + 747-C42		725-C42 + 731-C42			

Some configurations are shown with optional O-rings and some require multiple fittings.



07. Safety Posts

Interclamp Safety Post

A simplified modular handrail system

- Saves time and money.
- Simplifies specification and installation.
- Ball standard replacement system.
- Off-the-shelf solutions.
- Available in 2 colours - Galvanised and Safety Yellow (see images).

Galvanised



Safety Yellow



Interclamp Safety Post is designed to be a replacement for traditional ball standard systems. Simply choose the posts and rails required and assemble on site.

400 Series - Standard Safety Posts

A rapid assembly and cost effective solution for industrial and workplace safety barriers. Ideal for machinery guardrails, zone segregation and personnel safety.



Size	Post	Mid Rail	Top Rail
C42	C42	C42	C42
D48	D48	D48	D48

Accessories



3m Rails



Disclaimer:
Products illustrated show Interclamp Safety Yellow Polyester Powder Coated Finish.
Horizontal tubes (pale yellow) are not included, as purchased separately.



800 Series - DDA Assist Posts

To help compliance with the Equality Act 2010 (formerly DDA) and Building Regulations Part M 2013 requirements, the 800 Series Assist DDA Safety Post offers a simple solution for creating DDA handrailing structures. Ideal for public access installations including shops, schools, colleges, banks, hospitals, restaurants and public institutions.

Offset Top & Offset Middle Rails

Level Sites

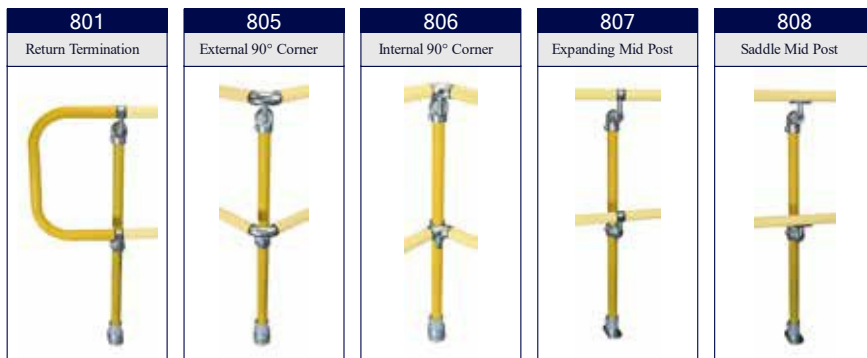

Sloping Sites (0-11°)

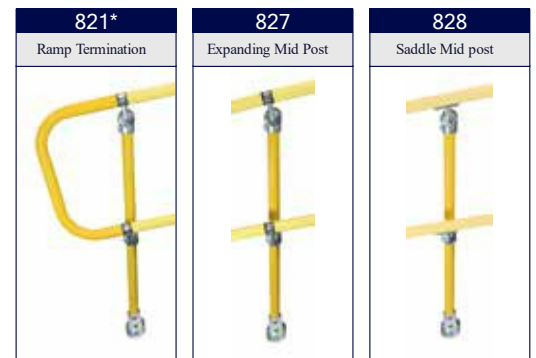

Size	Post	Mid Rail	Top Rail
C42	C42	C42	C42
D48	D48	C42	C42

Offset Top & Inline Middle Rails

Level Sites



Sloping Sites (0-11°)



Size	Post	Mid Rail	Top Rail
C42	C42	C42	C42
D48	D48	D48	C42

* 721 Return Bend must be cut to suit angle.

08. Pedestrian Barriers

Interclamp Pedestrian Barrier

A rapid assembly modular barrier system

- Fast, easy installation - long stretches of barrier can be installed quickly and simply.
- Minimises both design & fabrication times.
- Designed to be installed in conjunction with the standard Interclamp range including the Interclamp Assist DDA range.
- Staggered infill bars provide enhanced visibility.
- Reduced climbing potential due to the absence of a middle rail.
- Standard panel available off the shelf for rapid delivery.
- Can be delivered to site with pre-assembled uprights, ready to install.
- Durable galvanised finish as standard for use in demanding environments.
- Easily transported to sites as no long lengths of tube are required.

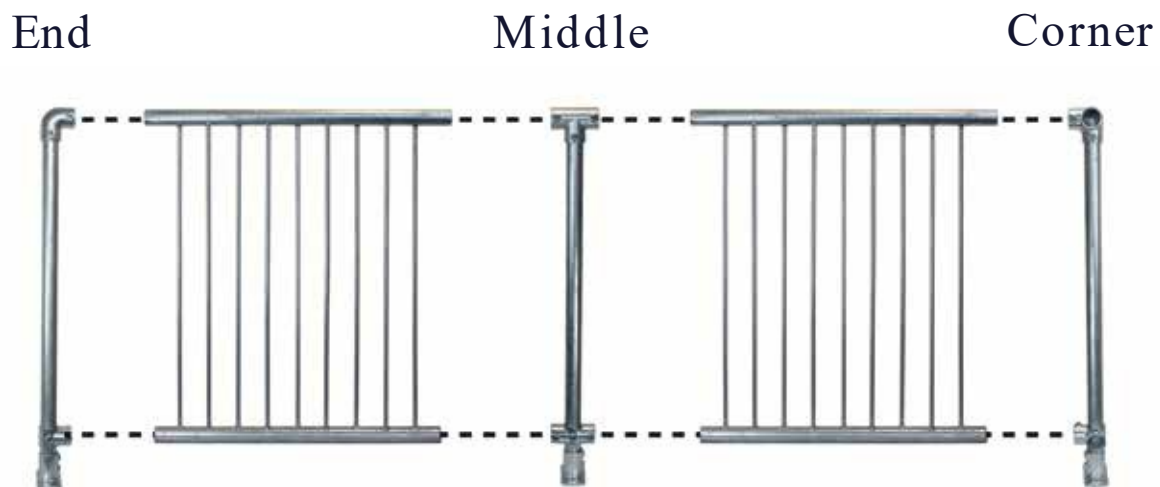

Specification

Top and bottom rails are 1 ½" nominal bore (48.3 mm od) tube with 12mm diameter solid vertical bars, designed to be compatible with our D48 range of Interclamp fittings. The vertical bars are staggered to increase drivers' visibility through the barriers at a wider range of angles. Following fabrication the barriers are hot-dipped galvanised in accordance with BS EN ISO 1461:2009. The barriers comply with the 100mm sphere rule when correctly installed with Interclamp fittings. NB. Raked panels are available. Standard finish is galvanised, powder coated panels are available at extra cost in a wide range of RAL or BS colours to suit your specification, where required.



392 Pedestrian Barrier

Available in 900mm and 1800mm widths

The Interclamp Pedestrian Barrier is designed to integrate fully with the Interclamp system and provide rapid construction of pedestrian control structures. The barrier offers strength, durability and versatility enabling it to be used in a wide variety of applications.

Panels can be shipped directly to site as a complete package by selecting the relevant posts for the installation (see below).

End



Middle



Corner



09. Easyguard



Interclamp Easyguard Roof-Edge Protection System

- Optimal protection of personnel
- Permanent and non-penetrative
- Free-standing or fixed systems
- Adjustable and adaptable
- Limited trip hazard
- Can be assembled in reverse for unobstructed walkways



Easyguard is a system of permanent freestanding handrails for roof perimeters and the designation of access ways and fire escapes, suitable for both retrofit and new build. Easyguard is non-penetrative, eliminating the risk of future leaks associated with penetrative systems and alleviating the need for weatherproofing around posts and associated costs. The system is flat footed and slides easily underneath rooftop obstructions, therefore providing minimal trip hazard.

Easyguard is galvanised to BS EN ISO 1461:2009 and is also available powder coated, again over galvanised steel to ensure the longevity of the system and its coating. The base plates are fitted with bonded ribbed rubber mats, which include an EPDM foam infill. The foam infill reduces heat transfer to the membrane to reduce membrane degradation. Easyguard is adjustable by up to 250mm, and is levelled to the line of the building and against the falls of the roof, improving the aesthetics from ground level. The system is designed to BS/EN/SR 15 1988, and is compliant to BS6180 for maintenance use, BS6399 Part 2, BS EN 13374 Class A and CP3 wind loads. Easyguard can be installed in reverse for unobstructed walkways and can be terminated by wall fixings, 2m return ends, or suitable counterweights.

New asphalt roofs may require tiles beneath base assemblies to prevent the system from sinking, with advice sought from your asphalt manufacturer. Heavier duty fixed rails can be designed to meet most loads and comply with BS6180. Fixed rails can be fixed to both vertical and horizontal faces of parapet walls or upstands for applications where a permanent free standing handrail will not suffice.



10. Accessories



Security Setscrews & Keys

An optional extra to the Interclamp product range, Interclamp Security Setscrews have been designed with a unique central recess. This means that they can only be inserted or removed using the Interclamp Security Key, to give added protection against the potential removal of installations by thieves and vandals.



Floor Grating Clip

The hot-dipped galvanised steel Interclamp Floor Grating Clip enables rapid fixing of traditional heavy duty steel open mesh flooring.

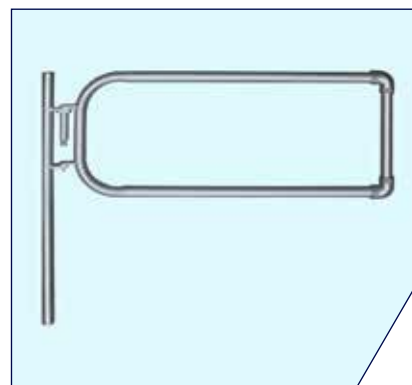

Self-Closing Gate

The simple solution to protect access points through fixed handrailing. We are always very happy to discuss your individual requirements for more specialised opening elements and bespoke sizes are also available on request.



Weld Elbows

To support the fabricator or specifier who prefers traditional welded tubular structures, a range of cost effective self-colour butt-weld elbows is provided.



Mesh Panels

Manufactured to order on request to suit your requirements, Mesh Panels are supplied welded to an 8mm rod frame and are available in common mesh sizes e.g. 50 x 50mm, 25 x 25mm and 50 x 25mm. Bent corner panels are also available.



Simple to specify



Easy to order



Rapid to assemble

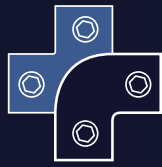

Interclamp®

DLHonline

0161 223 1990



For any application, the suitability or otherwise of the Interclamp system must first be assessed by the customer against relevant national standards, building regulations and/or Eurocodes and by reference to the Design and Installation Instructions available at www.interclamp.com/en/Installation/instructions. A printed copy of the Instructions is available on request. We accept no responsibility for any loss or damage arising from the misuse of Interclamp fittings. Please note that the ultimate responsibility for the correct choice of size and type of fitting for any application belongs with the customer. The customer is responsible for ensuring that the construction or structure is sufficiently strong to support the weight of its component parts plus any applied load, and that suitable fixings are used. Interclamp fittings must not be welded and we strongly recommend that types 132, 152 or 232 are always used where base plates are required, fitted so that the fixing holes are in line with the applied load. To provide sufficient stability, whole structures must not be made from swivel fittings alone. Whilst every effort has been taken to ensure the information given in this publication is correct, the right is reserved to alter or revise this information as and when necessary. No part of this publication may be reproduced without our written permission.

**DLHonline is a division of
Dale Lifting and Handling Specialists
2 Kelbrook Road,
Parkhouse Street Industrial Estate,
Manchester, M11 2QA
Telephone 0161 223 1990
Email sales@dale-lifting.co.uk**



www.dlhoneonline.co.uk